





# Keyboard Controller

PIH-800II

INSTRUCTION MANUAL

WARNING : TO REDUCE RISK OF FIRE OR ELECTRIC SHOCK ,  
DO NOT EXPOSE THIS APPLIANCE TO RAIN OR MOISTURE .

 <div style="display: inline-block; text-align: center;"><p><b>CAUTION</b></p><p><b>RISK OF ELECTRIC SHOCK</b></p></div> 
<p>CAUTION : TO REDUCE THE RISK OF ELECTRIC SHOCK, DO NOT OPEN COVER. NO USER SERVICEABLE PARTS INSIDE. REFER SERVICING TO QUALIFIED SERVICE PERSONNEL.</p>



The lightning flash with arrowhead symbol, within an equilateral triangle, is intended to alert the user to the presence of uninsulated "dangerous voltage" within the product's enclosure that may be of sufficient magnitude to constitute a risk of electric shock to persons.



The exclamation point within an equilateral triangle is intended to alert the user to the presence of important operating and maintenance (servicing) instructions in the literature accompanying the unit.

## PRECAUTIONS

- ⊗ **Do not drop or strike this equipment.**  
It will cause damage to the equipment.
- ⊗ **Do not install the equipment near any naked flames or heat sources.**  
The presents of flammable gas or object in the operating environment or exposing this unit to direct sunlight may cause fire and severe injury.
- ⊗ **Do not expose this unit to rain , moisture , smoke or dust environment.**  
May cause short circuit, fire and serious damage to this unit.  
Unplug this unit and have it checked by qualified service personnel.
- ⊗ **Do not cover the opening of the cabinet with cloth and plastic or to install this unit in poor ventilated places. Allow 10cm between this unit and its surroundings.**  
May cause overheat. The normal operating temperature is 0 °C ~ 40 °C.
- ⊗ **Do not continue to operate the unit under abnormal conditions such as detection of smoke, strange smell or no display on screen while power is turned on.**  
Contact qualified service personnel for help.
- ⊗ **Do not touch the power connection with wet hands.**  
May cause short circuit or electric shock.
- ⊗ **Do not damage the power cord or leave it under pressure.**  
May cause fire or shock hazard.
- ⊗ **Do not operate this unit near magnet, speaker system, etc., to avoid unnecessary magnetic interference.**  
These interference will cause color confusion and screen fluctuation.
- ⊗ **Do not drop metallic parts through slots.**  
This could permanently damage the appliance.
- ⊗ **Connection cables should be grounded properly.**  
Sudden surge such as lightning will damage the system permanently.



# PREFACE

Thank you for choosing PIH-800II keyboard. For trouble free installation and optimum performance please read this manual thoroughly before attempting installation or operation.

## CONTENTS

	Page
1. Introduction	2
2. Specifications	2
3. Keyboard Layout	2
4. Matrix and Receiver Operation	3,4
5. Fast Speed Dome Operation	5,6
6. Wiring Diagrams	6
7. Master & Slave Settings	7

# 1. INTRODUCTION

The PIH-800II is a control keyboard For a range of matrix switchers, dome cameras and telemetry receivers. It allows operation of all the functions of that equipment and provides a simple operator interface.

When matrix is present in the system, up to 8 keyboards can be used, however, one keyboard must always be configured as the Master, having greater access to settings than the slaves.

If when keyboard is controlling Fast Domes directly without matrix, only one keyboard is allowed. Data is transmitted via screened, twisted pair cables, usually in serial configuration.(RS-485)

# 2. SPECIFICATIONS

Data Communication	:	RS-485, 9600 Baud
Input Voltage	:	12Vdc
Power Consumption	:	250mA
Operating Temperature	:	-5 °C ~ +60 °C
Weight	:	1.5Kg
Dimensions	:	370(L) × 190(W) × 83(H)mm

# 3. KEYBOARD LAYOUT

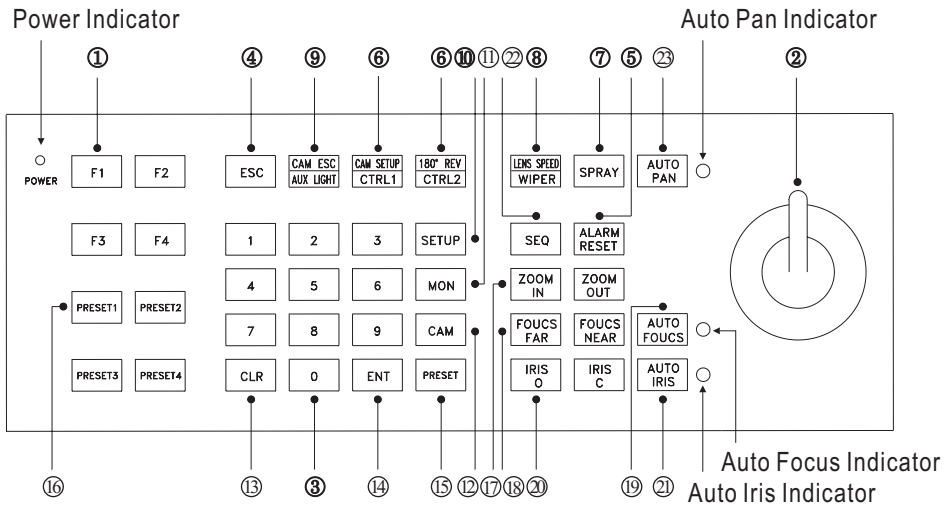

PS. Key Functions :

1. Refer to Page 3,4 when connects to Matrix Switcher.
2. Refer to Page 5,6 when connects to Fast Dome Camera directly.

## 4. MATRIX AND RECEIVER OPERATION

### ① Function Keys

F1 Turns on or off the on-screen display.(time,date monitor and camera number)

F2 Displays the log of last 10 camera or video loss alarms.

F3 Adjust the position of the on-screen display.

F4 Sets the P/T/Z preset position groups.

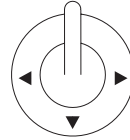

### ② Joystick

➤ Controls the movement of pan and tilt cameras.

➤ Matrix Setup Menu Selection.

➤ Under controlling single fast dome, "9013+CLR" can rectify the joystick.

### ③ Numeric Keys

0~9 for entering camera, monitor numbers ets.

### ④ ESC Key

This can be used to exit from any function or programming.

### ⑤ ALARM RESET Key

Clears alarms and video loss alarms.

### ⑥ ⊗ CTRL 1 / CAM SETUP Key

➤ A spare control key when keyboard connects to PIH-820 (Receiver).

➤ OSD Setup Menu recall key when keyboard connects to PIH-7625 (Day & Night Fast Dome)

### ⑥ ⊗ CTRL 2 / 180° REV Key

➤ A spare control key when keyboard connects to PIH-820 (Receiver).

➤ 180° Horizontal Instant Flip key when connects to Fast Dome Camera.

### ⑦ SPRAY Key

This operates the washer system where fitted to a camera housing.

### ⑧ WIPER / LENS SPEED Key

➤ The housing wiper control key when connects to PIH-820 (Receiver).

➤ Manual speed switch of Zoom, Focus and Iris when connects to PIH-7625 (Day & Night Fast Dome)

### ⑨ AUX LIGHT / CAM ESC Key

➤ Auxiliary lighting switch when connects to PIH-820 (Receiver).

➤ OSD Setup Menu escape key when connects to PIH-7625 (Day & Night Fast Dome)

- ⑩ SETUP Key  
Enters Matrix Setup Mode.
- ⑪ MON Key  
Selects a particular monitor.
- ⑫ CAM Key  
Selects a particular camera.
- ⑬ CLR Key  
Selects a particular camera.
- ⑭ ENT Key  
Used to enter or confirm data and programming.
- ⑮ PRESET Key  
For recalling and storing preset positions.
- ⑯ PRESET 1 / 2 / 3 / 4 Keys  
These Keys instantly move the selected camera to relevant preset position 1-4
- ⑰ ZOOM IN / ZOOM OUT Keys  
Manually adjusted the zoom lens.
- ⑱ FOCUS FAR / FOCUS NEAR Keys  
Manually adjusted the focus of the lens.
- ⑲ AUTO FOCUS Key  
Auto Focus control key when connects to Fast Dome Camera.
- ⑳ IRIS O / IRIS C Keys  
Manually opens or closes the iris of the lens.
- ㉑ AUTO IRIS Key  
Sets the iris to automatic mode.
- ㉒ SEQ Key  
Starts an automatic switching sequence on a particular monitor.
- ㉓ AUTO PAN Key  
Puts a Pan/Tilt head into auto pan mode or a Fast Dome Camera into auto tour mode.

## 5. FAST DOME CAMERA OPERATION

### ① Numeric Keys

0~9 for entering camera, monitor numbers ets.

### ② Function Keys

F1 To set the speed that Fast Dome Camera travels between preset positions.

F2 To set the dwell time of preset position.

F3 To store the preset data

F4 To set the preset groups



### ③ Joystick

➤ Controls the movement and speed of the dome.

➤ Under controlling single fast dome, "9013+CLR" can rectify the joystick.

### ④ ALARM RESET Key

Clears alarms and video loss alarms.

### ⑤ ⊗ CTRL1 / CAM SETUP Key

➤ A spare control key when keyboard connects to PIH-820 (Receiver).

➤ OSD Setup Menu recall key when keyboard connects to PIH-7625 (Day & Night Fast Dome).

### ⊗ CTRL 2 / 180° REV Key

➤ A spare control key when keyboard connects to PIH-820 (Receiver).

➤ 180° Horizontal Instant Flip key when connects to PIH-7625 (Day & Night Fast Dome).

### ⑥ WIPER / LENS SPEED Key

➤ The housing wiper control key when connects to PIH-820 (Receiver).

➤ Manual speed switch of Zoom, Focus and Iris when connects to Fast Dome Camera.

### ⑦ AUX LIGHT / CAM ESC Key

➤ Auxiliary lighting switch when connects to PIH-820 (Receiver).

➤ OSD Setup Menu escape key when connects to PIH-7625 (Day & Night Fast Dome).

### ⑧ CAM Key

Selects a particular camera.

### ⑨ PRESET Key

For recalling preset positions.

⑩ PRESET 1 / 2 / 3 / 4 Keys

These Keys instantly move the selected camera to the relevant preset position 1-4.

⑪ ZOOM IN / ZOOM OUT Keys

Manually controls the zoom lens.

⑫ FOCUS FAR / FOCUS NEAR Keys

Manually adjusts the focus of the lens.

⑬ AUTO FOCUS Key

Auto Focus control key when connects to Fast Dome Camera.

⑭ IRIS O / IRIS C Keys

Manually opens or closes the iris of the lens.

⑮ AUTO IRIS Key

Sets the iris to automatic mode.

⑯ AUTO PAN Key

Puts a Pan/Tilt head into auto pan mode or a Fast Dome Camera into auto tour mode.

## 6. WIRING DIAGRAM

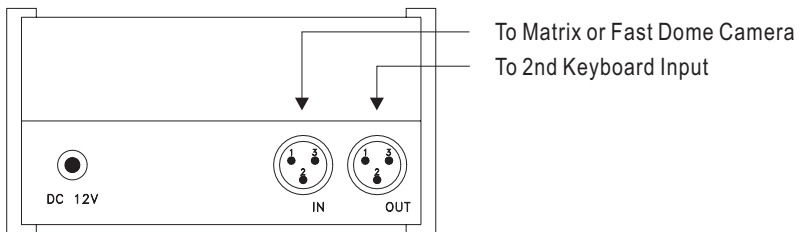

RS-485 (IN / OUT) :

1st Pin connects to positive, 2nd Pin to negative, leave the 3rd Pin.

# 7. MASTER & SLAVE SETTINGS

## Fast Dome

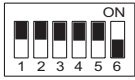

6 Setting OFF

## Alarm Buzzer



5 Setting OFF - Silent  
Setting ON - ON

## Key Sound



4 Setting OFF - Silent  
Setting ON - Beep

## Matrix

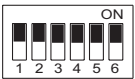

1st Keyboard



2nd Keyboard



3rd Keyboard



4th Keyboard

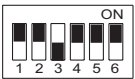

5th Keyboard



6th Keyboard

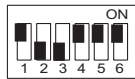

7th Keyboard

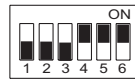

8th Keyboard



**MERIT LI-LIN ENT. CO., LTD**

<http://www.meritlilin.com>

66-80011CSE